

WORLD CLASS WINCHES

RELIABLE – DEPENDABLE – UNCOMPLICATED

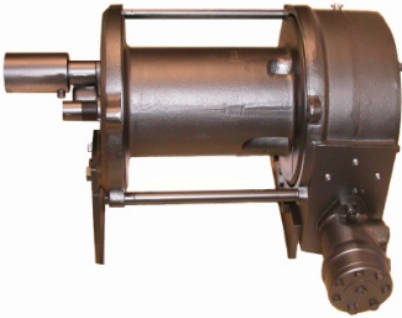

SEPGAIN H70

Technical Data

Freespool clutch

Max. pulling force

- bottom rope layer
- top rope layer

Max. rope speed

- bottom rope layer
- top rope layer

Maximum oil pressure

Maximum oil flow

Rope drum diameter

Rope diameter

Rope length

Rope MBL (EN 14492-1)

Number of rope layers

Winch weight

Rope weight

Dimensional drawing (mm)

Product # 62.56-045

Manual

70 kN

54 kN

6 m/min

8 m/min

200 bar

70 l/min

180 mm

14 mm

40 m

≥ 140 kN

3

125 kg

45 kg

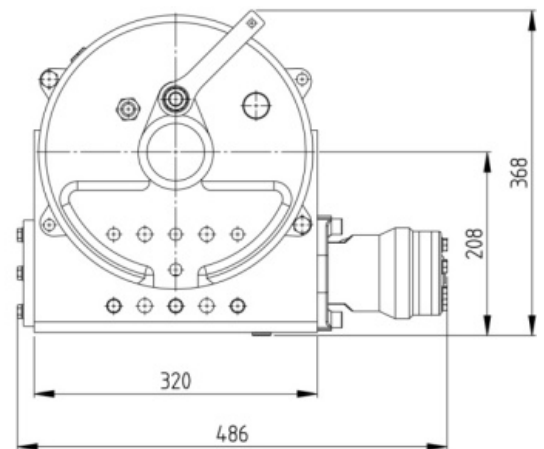
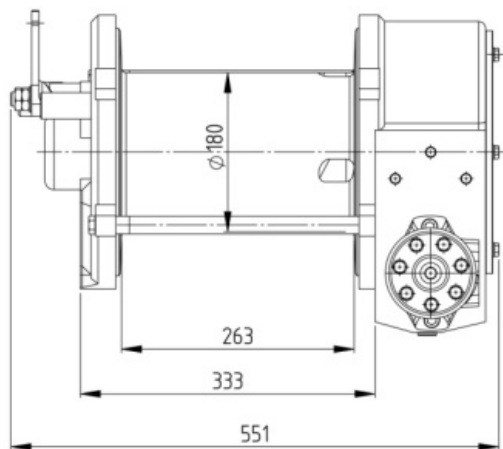

Compliant to EN 14492-1

