

WORLD CLASS WINCHES

RELIABLE – DEPENDABLE – UNCOMPLICATED



SEPDURANCE H38

Technical Data

Freespool clutch

Max. pulling force

- bottom rope layer
- top rope layer

Max. rope speed

- bottom rope layer
- top rope layer

Maximum oil pressure

Maximum oil flow

Rope drum diameter

Rope diameter

Rope length

Rope MBL (EN 14492-1)

Number of rope layers

Winch weight

Rope weight

Dimensional drawing (mm)

Product # 73.06-017

Pneumatic

38 kN
24 kN

13 m/min
21 m/min

175 bar
60 l/min

90 mm
10 mm
30 m
≥ 76 kN
4

50 kg
13 kg

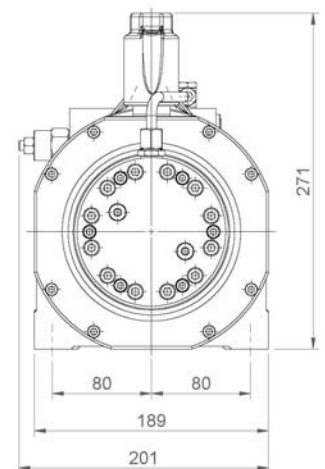
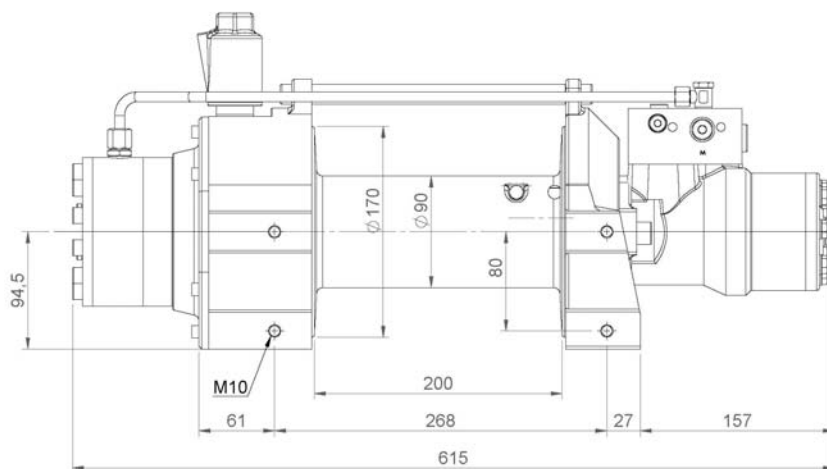

Compliant to EN 14492-1

