

WORLD CLASS WINCHES

RELIABLE – DEPENDABLE – UNCOMPLICATED



SEPDURANCE H90

Technical Data

Freespool clutch

Max. pulling force

- bottom rope layer
- top rope layer

Max. rope speed

- bottom rope layer
- top rope layer

Maximum oil pressure

Maximum oil flow

Rope drum diameter

Rope diameter

Rope length

Rope MBL (EN 14492-1)

Number of rope layers

Winch weight

Rope weight

Product # 73.08-023

Hydraulic/Pneumatic

90 kN

56 kN

6 m/min

10 m/min

200 bar

60 l/min

126 mm

14 mm

30 m

≥ 180 kN

4

92 kg

25 kg

Dimensional drawing (mm)

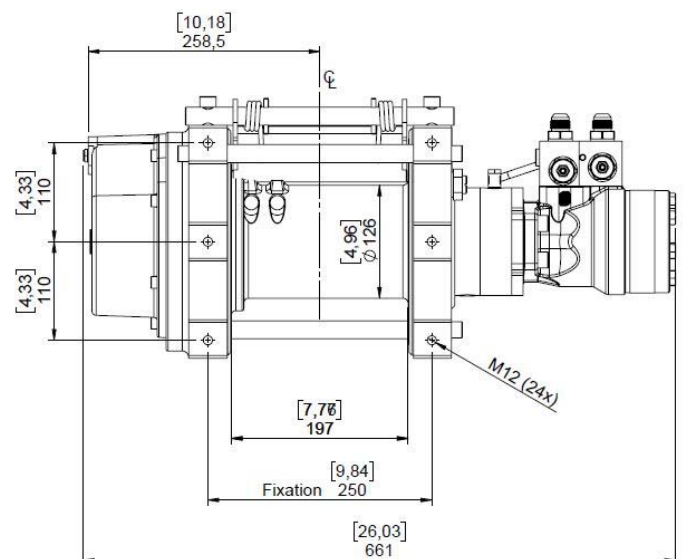
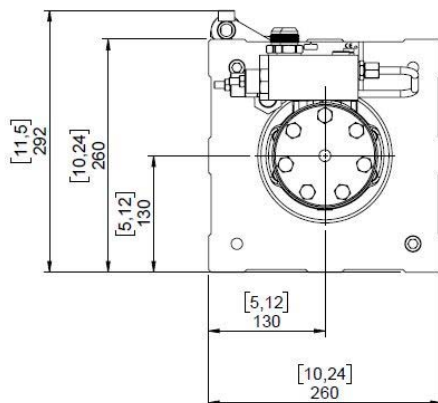

Compliant to EN 14492-1 and SAE J706

